

Original BMW Accessories. Installation Instructions.



iPod Interface Retrofit

BMW 3 Series Saloon (E90)

BMW 3 Series Touring (E91)

BMW 3 Series Coupé (E92)

These installation instructions are only valid for cars with SA 663 (BMW Professional radio), SA 606 (Business navigation system) or SA 609 (Professional navigation system).

Retrofit kit No. 65 41 0 412 881 iPod interface retrofit kit

Installation time

The installation time is approx 1.0 hour, but may vary depending on the condition of the car and the equipment in it. The installation time will increase by approx. 0.25 hours for cars with SA 672 (CD changer).

In general the car must be upgraded to the latest I stage status by flashing before starting the work. Depending on the production age of the car and the work already carried out on the car, the programming times will vary, which means that we cannot quote a specific time at this point.

The installation time does not include any time for programming/encoding, as this depends on the age of the car and the equipment in it.

Important information

These installation instructions are primarily designed for use within the BMW dealership organisation and by authorised BMW service companies.

In any event, the target group for these installation instructions is specialist personnel trained on BMW cars with the appropriate specialist knowledge.

All work must be completed using the latest BMW repair manuals, circuit diagrams, servicing manuals and work instructions, in a rational order, using the prescribed tools (special tools) and observing current health and safety regulations.

To avoid unnecessary extra work and/or costs, if any installation or function problem occurs, after a brief troubleshooting session (approx. 0.5 hours), please contact the following:

- 1. Either your national subsidiary or your regional office, or**
- 2. The Support team via the Aftersales Assistance Portal (ASAP) using the optional technical parts support application.**

Specify the chassis number and the part number of the installed retrofit kit and give a precise description of the problem.

Do not archive the hard copy of these installation instructions since daily updates are made by ASAP!

Pictograms:



Denotes instructions that draw your attention to special features.

◀ Denotes the end of the instruction or other text.

Installation information

All pictures show LHD cars; proceed accordingly on RHD cars.

Ensure that the cables/lines are not kinked or damaged as you install them in the car. Costs incurred as a result of this will not be reimbursed by BMW AG.

Additional cables/lines that you install must be secured with cable ties.

If the specified PIN chambers are occupied, bridges, double crimps or twin-lead terminals must be used.

After the installation work the retrofit must be programmed / coded using SSS (software service station) via the **Retrofit** path.

When routing fibre optic cables, make sure the bending radius is no less than 25 mm.

Assembly instructions for cars with SA 672 (CD changer)

- The CD changer must be removed.

Special tools required

00 9 317 Trim wedge

Contents

Section	Page
1. Parts list	4
2. Preparatory work	5
3. Connection diagram	6
4. Installation and cabling diagram.....	7
5. To install the interface and connection cable.....	8
6. To connect the cable kit and connection cable	10
7. Concluding work and coding	12
8. Circuit diagram	13

1. Parts list

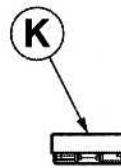
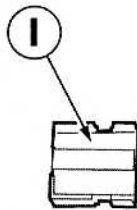
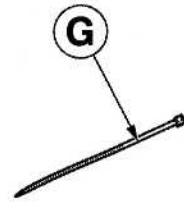
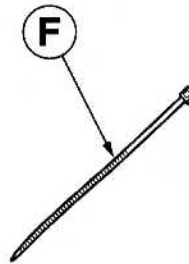
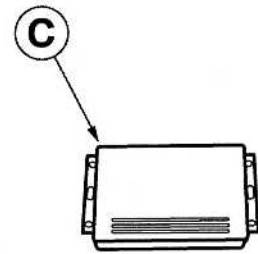
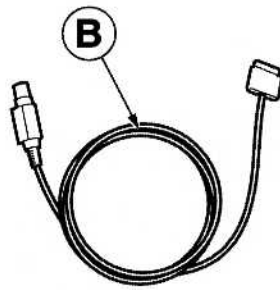
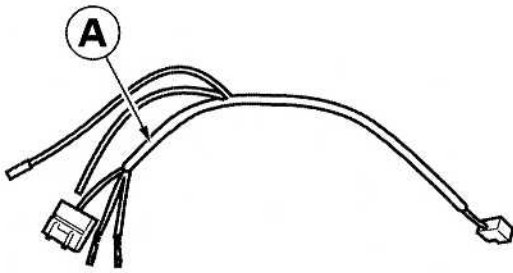

087 0628 Z

Legend

- A** Cable kit
- B** Connection cable
- C** Interface
- D** Felt (4x)
- E** Sealing strip (4x, not required)
- F** Cable tie 445 x 4.8 mm (2x)
- G** Cable tie 200 x 3.6 mm (10x)
- H** Miniature connector (2x, not required)
- I** Black 4-pin socket casing
- J** Grommet
- K** Fibre optic cable connector (cars with a CD changer only)
- L** Fibre optic cable casing (not required)

2. Preparatory work

	TIS No.
Conduct a brief test	---
Disconnect negative pole of battery	12 00 ...
The following components must be removed first of all	
Décor strip on right of dashboard	51 45 380
Central dashboard trim	51 45 310
Glove compartment	51 16 360
Heating/air-conditioning control	64 11 377
Audio system controller (ASK) or Car Communication Computer (CCC)	65 12 200
	65 83 010

3. Connection diagram

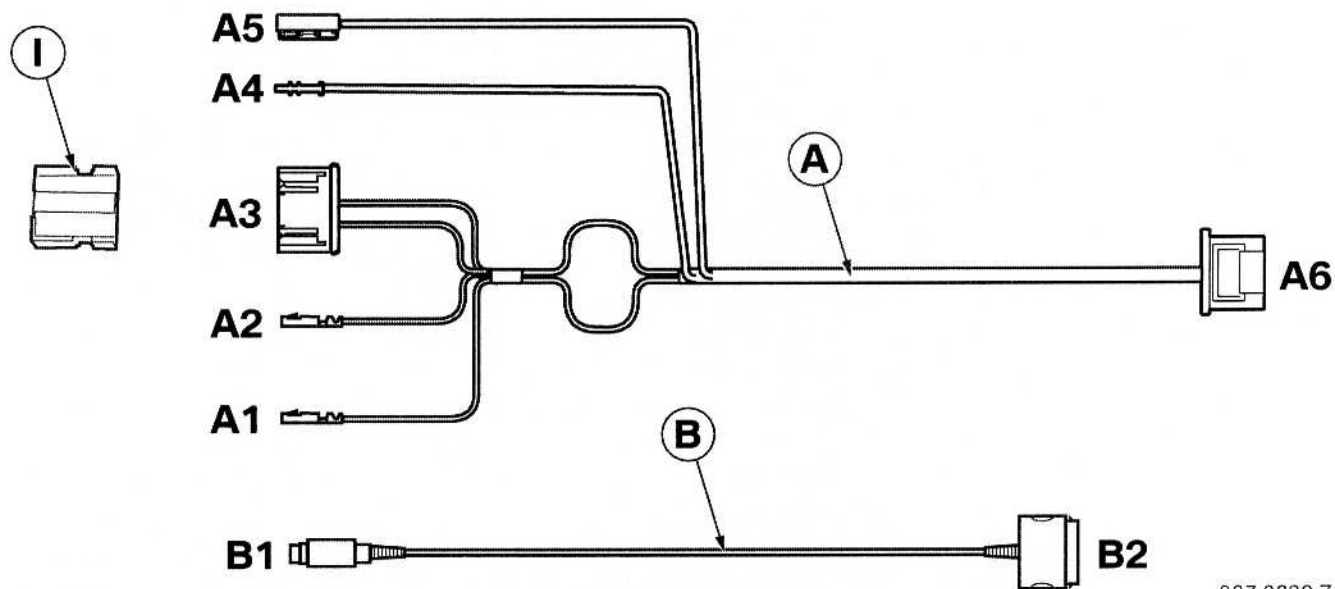

087 0629 Z

Branch/Item	Designation	Signal	Cable colour / Cross-section	Connection location in the car	Abbreviation / Slot
A	Cable kit	---	---	---	---
A1	Socket contact	Terminal 30	RT 2.5 mm ²	On ASK or CCC	X13812 PIN 15
A2	Socket contact	Terminal 31	BR 2.5 mm ²	On ASK or CCC	X13812 PIN 12
A3	Black 4-pin plug casing	---	---	On socket casing I	---
A4	Fibre optic cable	MOST	GN	On ASK or CCC	X13815 PIN 2
A5	Fibre optic cable connector	MOST	GN	On disconnected fibre optic cable of ASK or CCC	---
A6	Black 4+2-pin socket casing	---	---	On interface C	---
B	Connection cable	---	---	---	---
B1	Black 12-pin socket casing	---	---	On interface C	---
B2	iPod connection plug	---	---	On iPod	---
I	Black 4-pin socket casing	---	---	With cables disconnected from ASK or CCC on branch A3	---

4. Installation and cabling diagram

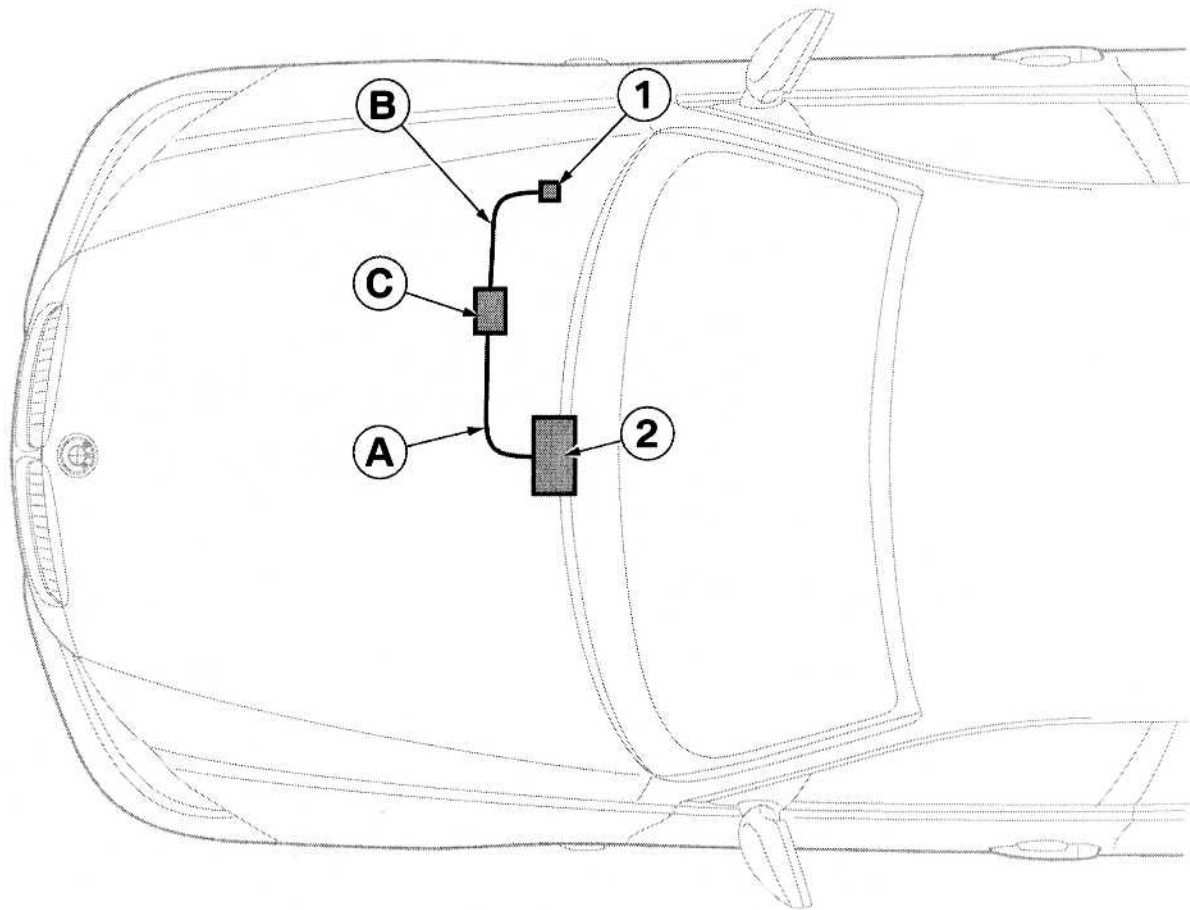

087 0652 Z

Legend

- A** Cable kit
 - B** Connection cable
 - C** Interface
-
- 1** iPod connection plug **B2**
 - 2** ASK or CCC, plug **X13812** and **X13815**

