

REP-REP-RAE9018M57T2-1800018_SCR Removing and installing complete exhaust system (M57T2 with SCR)

VIN: XXXXXXX Vehicle: 3/E90/SEDAN/335d/M57/AUTO/USA/LL/2010/10
System 3.42.40.11060 Data R3.42.40.11060
Version: Version:

18 00 020**Removing and
installing complete
exhaust system
(M57T2 with SCR)****Special tools required:**

- 11 7 030
- [31 2 220](#)

**Warning!**

Risk of burning!

Only perform this work after engine has cooled down.

Danger of injury!

Removal of the exhaust system must be carried out with the assistance of a second person.

Support exhaust system with jack and special tool [31 2 220](#).

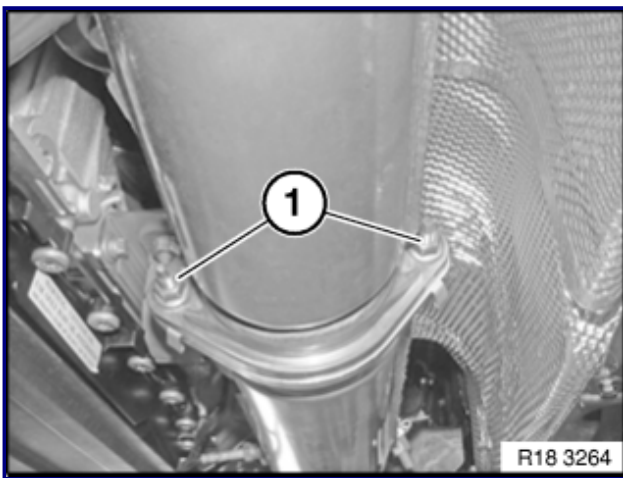
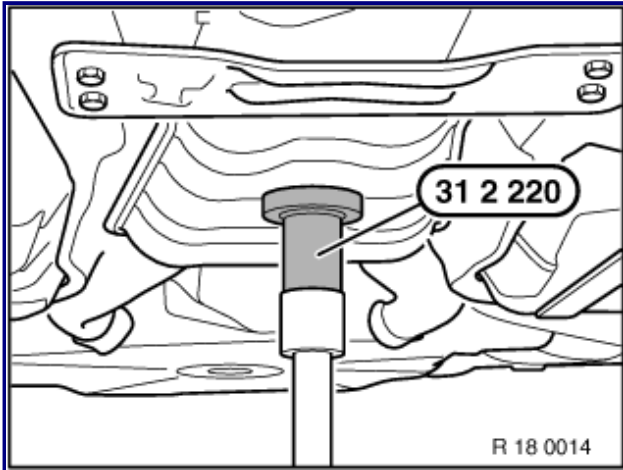

Unscrew nuts (1).
 Replace seal.
 Replace self-locking nuts.
 Tightening torque [18 31 10AZ](#).

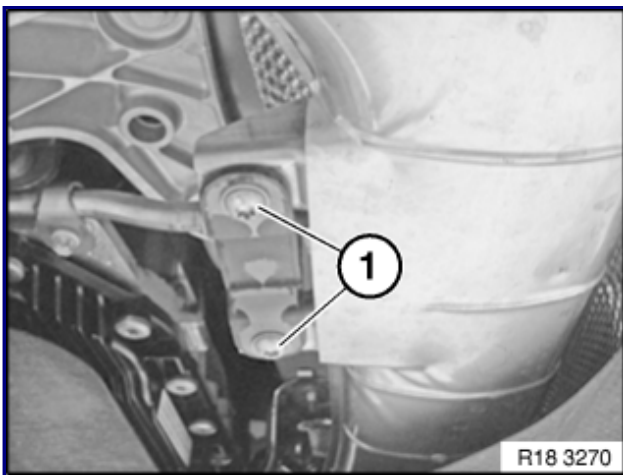

Release screws (1).
 Tightening torque [18 31 11AZ](#).

Release nitrogen oxide sensor (1) with special tool 11 7 030.
 Tightening torque [18 31 2AZ](#).
 Unclip nitrogen oxide sensor lead at clamps (2).

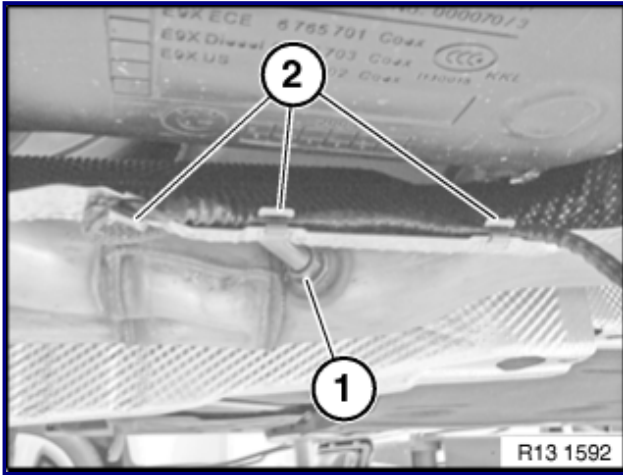

Installation note:

If a nitrogen oxide sensor is reused, apply a thin coating of Never Seez compound to thread only.

Do not clean the sensor section which protrudes into the exhaust line and ensure that it avoids all contact with lubricants.

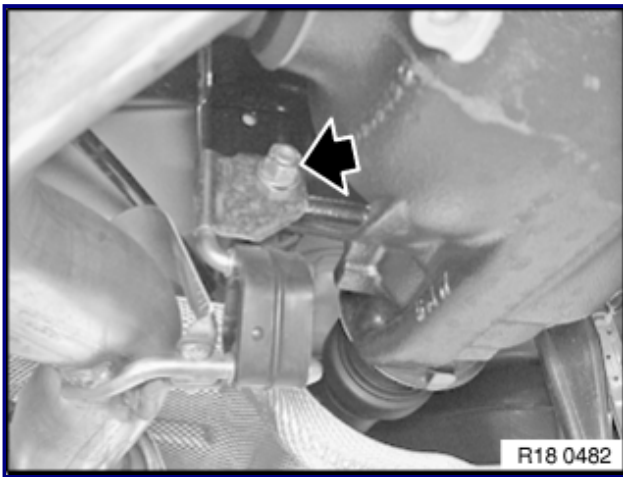

Unfasten nut.

Tightening torque [18 31 12AZ](#).

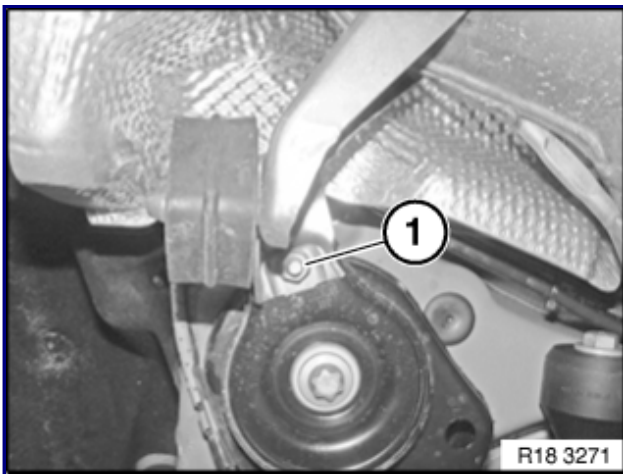

Release bolt and remove holder (1).

Tightening torque [18 31 8AZ](#).

Unfasten screws and remove holder.

Tightening torque [18 31 13AZ](#).

Note:

Texts refer to and illustrations show the left side. The procedure is identical for the

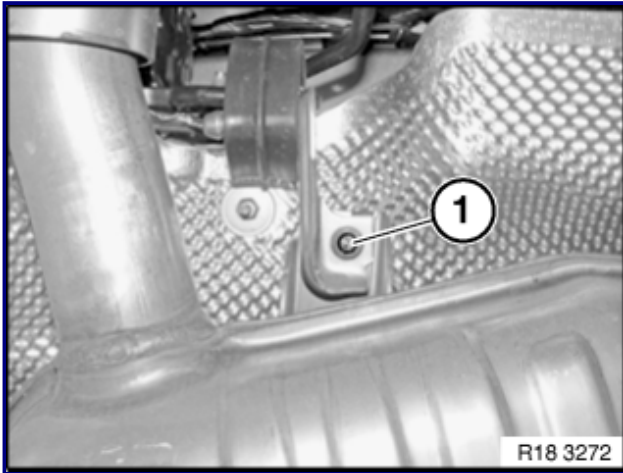

right side.

Carefully lower exhaust system with assistance of a second person.



Installation note:

Check rubber mounts for damage.
Replace damaged rubber mounts.
Check exhaust system for leaks.



After completing work:

Carry out SCR adjustment using BMW
Diagnosis and Information System.

Refer to:

- Service function
- SCR systems
- Carry out activation and adjustments